

1次予選

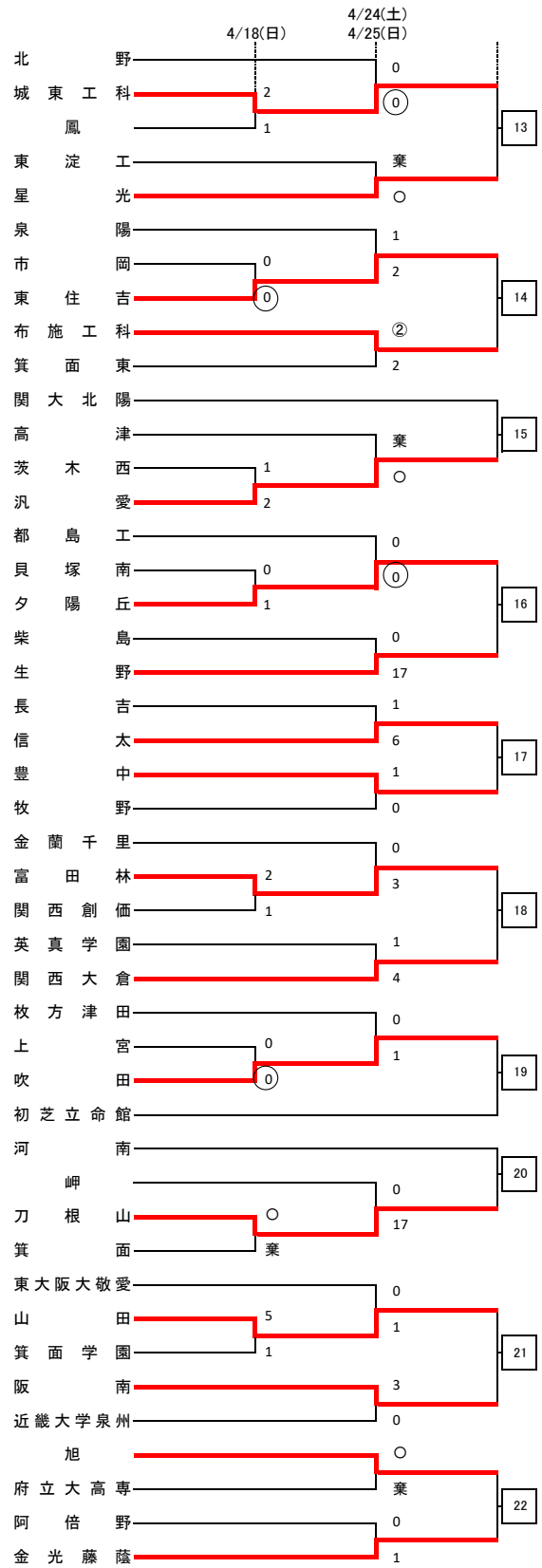
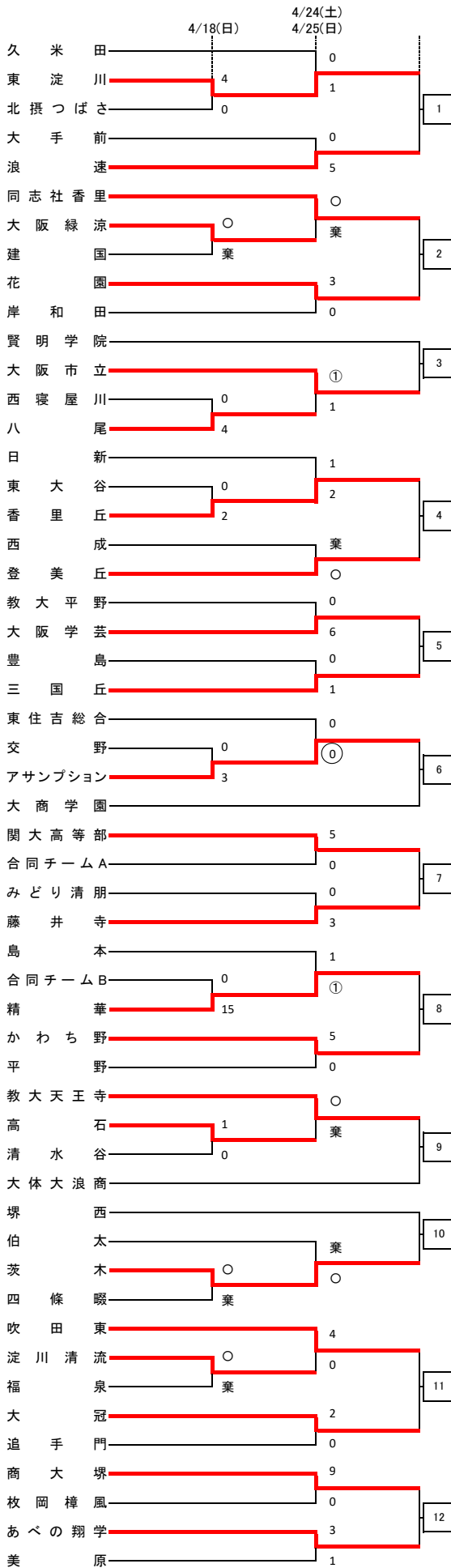

試合開始時刻

1回戦	① 9:30 ② 11:00 ③ 12:30 ④ 14:00
	PM ① 13:30 ② 15:00
2回戦	① 9:30 ② 11:00 ③ 12:30 ④ 14:00
3回戦	① 9:30 ② 11:10 ③ 12:50 ④ 14:30

1次予選

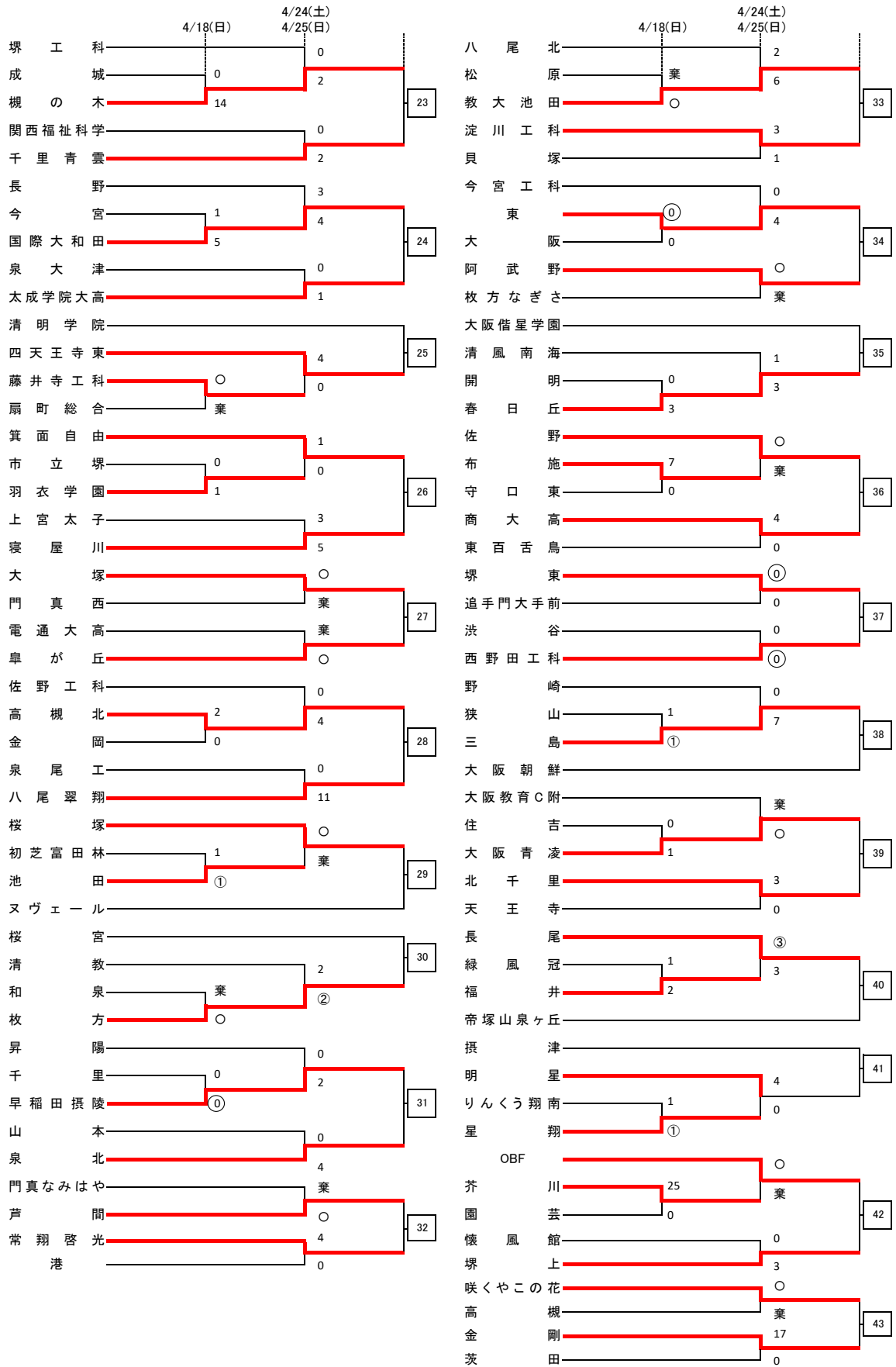

*合同チームAは西高校と淀商業高校、合同チームBは勝山高校と布施北高校の合同チームです。
 *1・2回戦 午後(PM)開催の会場の試合開始時刻は【 ①13:30 ②15:00 】となります。

2次予選

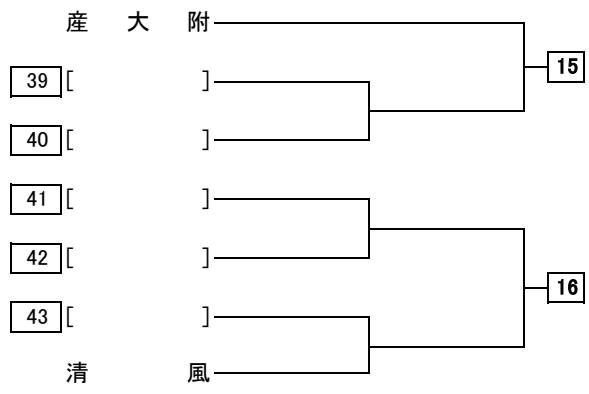
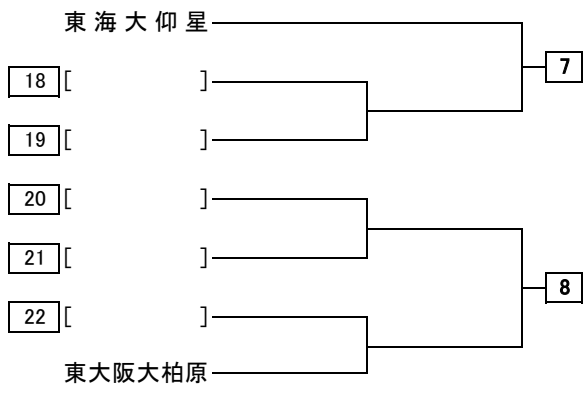
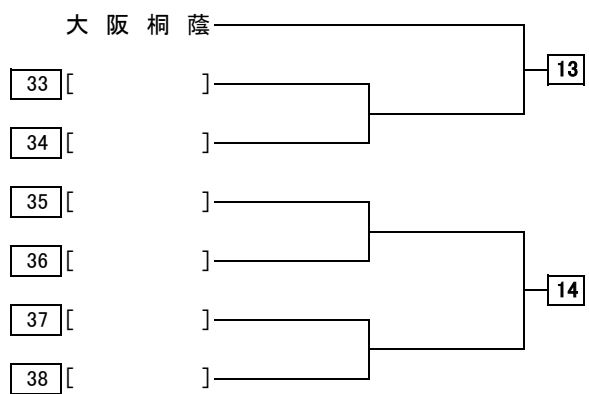
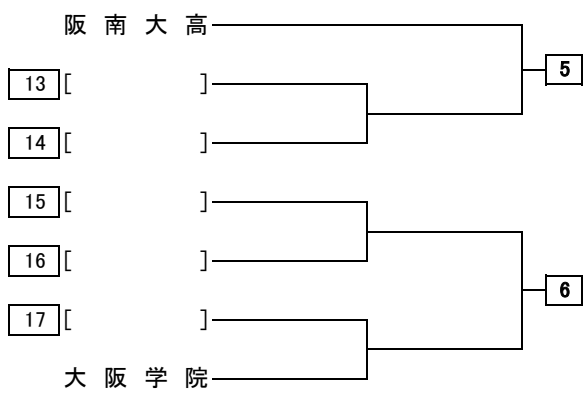
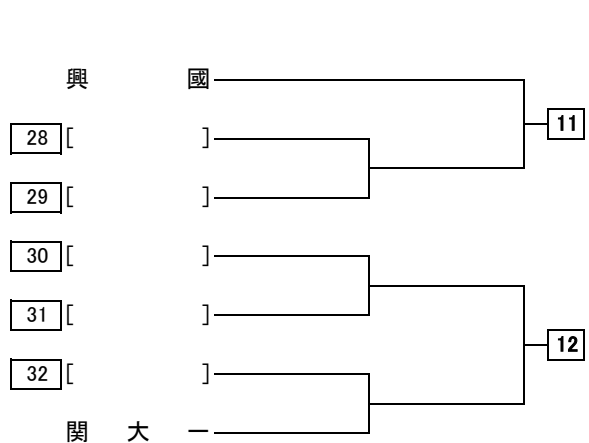
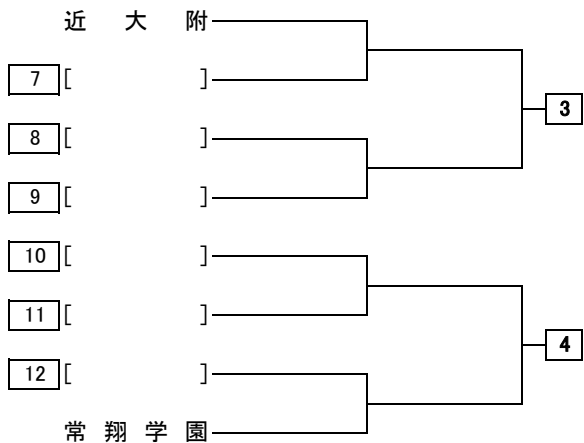
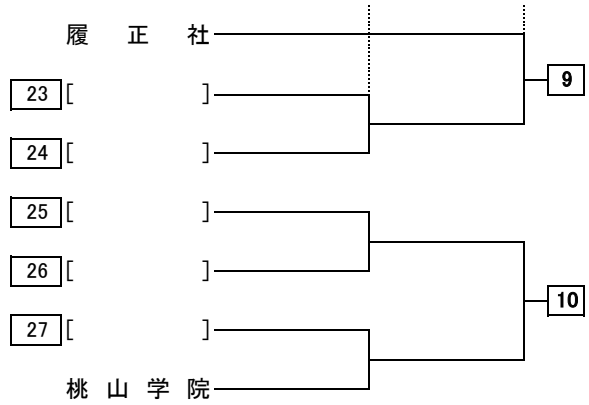
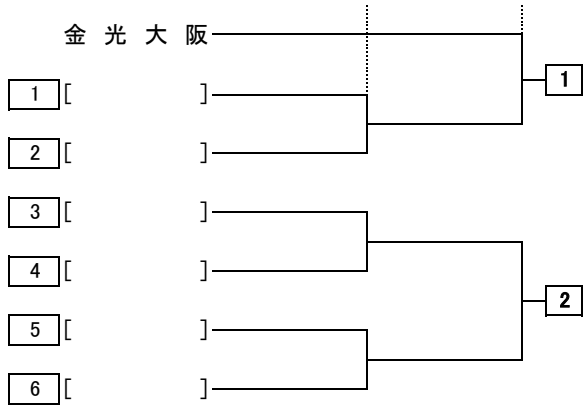

試合開始時刻	4回戦	① 9:30	② 11:10	③ 12:50	④ 14:30
	5回戦	① 9:30	② 11:10	③ 12:50	④ 14:30

中央トーナメント

